

Multi-functional precision thermometer Model CTR4000

WIKA data sheet CT 60.25

Applications

- Pharmaceutical industry
- Industry (laboratory, workshop and production)
- Temperature sensor and transmitter manufacturers
- Calibration service companies and service industry

Special features

- High accuracy
- Innovative and intuitive user interface
- Versatile applications by measuring thermocouples and resistance thermometers
- Logger and scan functions
- Up to 44 channels possible



Multi-functional precision thermometer,
model CTR4000

Description

Application

The model CTR4000 precision thermometer provides a complete measurement and control interface for users wishing to make high-accuracy temperature measurements or calibrate thermometers. It supports a wide range of thermometer types, including 25 Ω SPRTs, 100 Ω PRTs, thermistors and thermocouples.

The CTR4000 is a high-accuracy measuring instrument designed for laboratory and industrial temperature measurements and calibration applications.

Functionality

The instrument will operate with all 3- and 4-wire (S)PRTs (25 Ω , 100 Ω) platinum resistance thermometers as well as most standard international thermocouple types and NTC thermistors. The following temperature measuring units are selectable: $^{\circ}\text{C}$, $^{\circ}\text{F}$, K. Base measuring units mV and Ω are also displayed. The temperature values will be calculated through common conversion of the base measurement.

Due to the wide range of this instrument it makes individual instruments needless and makes the calibration cost-effective.

The CTR4000 is offered in two versions: standard and advanced.

The advanced version (CTR4000-A) has selectable excitation currents and standby currents for PRT probes. The advanced version also has increased measurement accuracy for PRT probes.

The standard version (CTR4000-S) has fixed excitation current for PRT probes.

Features included:

- Excellent and high-accuracy measurement technology for the registration of different types of thermometers
- Large graphic touchscreen for temperature measurement values as well as configuration settings and statistical results
- Logger and log-data transfer to USB stick or communication interface
- Scan function with a live screen and graph
- Communication interfaces available for automated monitoring and calibration applications

Specifications

Model CTR4000

Multi-functional precision thermometer	
Input	
Input channels	4
Channel 1 + 2	Resistance thermometers with 5-pin DIN connector
Channel 3 + 4	Thermocouple with standard miniature 2-pin thermocouple plug
Scanner box	Up to 4 modules
	Max. 44 channels (in total)
	Each module has 10 channels
Input connections	5-pin DIN connector or bare cable ends (resistance thermometer or thermistor)
	Standard miniature 2-pin thermocouple plug or bare cable ends (thermocouple)
Data entry format	ITS-90 and CvD for calibrated resistance thermometers; or EN 60751 standard conversion for uncalibrated resistance thermometers
	TC polynomial for calibrated thermocouples; or EN 60584 standard conversion for uncalibrated thermocouple
	Steinhart and Hart for NTC thermistors
Display update rate	500 ms
Measuring range	
PRT/SPRT	Measuring range 0 ... 500 Ω
	-200 ... +962 $^{\circ}\text{C}$ [-328 ... +1,764 $^{\circ}\text{F}$]
	3- and 4-wire measurement
Thermocouple	Measuring range -9.8 ... +76.4 mV corresponding to the range of the thermocouple E
	-200 ... +1,820 $^{\circ}\text{C}$ [-454 ... +3,308 $^{\circ}\text{F}$]
	Types B, C, D, E, J, K, N, R, S, T in accordance with EN 60584
Thermistor	0 ... 500 k Ω
Digital display	
Display	Colour TFT display including projective capacitive touchscreen with a resolution of 800 x 480 pixels
Resolution	0.0001 K / 0.00001 Ω / 0.00001 mV
Display units	$^{\circ}\text{C}$, $^{\circ}\text{F}$, K, mV and Ω
Functions	
Real-time clock	Integrated clock with date
Case	
Dimensions (W x H x D)	449 x 191 x 192 mm [17.7 x 7.5 x 7.6 in]
Weight	4.8 kg [10.5 lbs]

Accuracies ¹⁾		
Resistance thermometers		
Temperature accuracy	4-wire	CTR4000-A : 3.75 mK CTR4000-S : 5 mK
	3-wire	CTR4000-A : 0.03 K CTR4000-S : 0.03 K
Temperature conversions	Standard EN 60751, CvD, ITS-90	
Sensor currents	CTR4000-A: 0.5 mA, 1 mA, 2 mA, $\sqrt{2}$ CTR4000-S: PT25: 2 mA, $\sqrt{2}$ PT100: 1 mA, $\sqrt{2}$	
Standby currents	$R_0 < 50 \Omega$	0 ... 125 Ω 2 mA
	$R_0 \geq 50 \Omega$	0 ... 500 Ω 1 mA

Accuracies ¹⁾	
Measuring time	3 seconds refresh rate
Thermocouple	
Base measurement ²⁾	±% of reading + μV ±0.004 % + 2 μV
Temperature accuracy	Type B ±0.09 °C + ±0.025 % of reading
	Type C ±0.57 °C + ±0.057 % of reading
	Type D ±0.60 °C + ±0.059 % of reading
	Type E ±0.05 °C + ±0.031 % of reading
	Type J ±0.07 °C + ±0.030 % of reading
	Type K ±0.09 °C + ±0.035 % of reading
	Type N ±0.08 °C + ±0.035 % of reading
	Type R ±0.27 °C + ±0.020 % of reading
	Type S ±0.27 °C + ±0.020 % of reading
Type T ±0.09 °C + ±0.025 % of reading	
Temperature conversions	Standard EN 60584, polynomial
Measuring time	3 seconds refresh rate
Cold junction compensation	Internal, external or channel Accuracy internal cold junction compensation ±0.15 K
Thermistor	
Accuracies	0 ... 400 Ω ±0.006 Ω
	400 Ω ... 50 kΩ ±0.01 % of reading
	50 ... 500 kΩ ±0.02 % of reading
Temperature conversions	Steinhart-Hart, polynomial
Sensor currents	0 ... 450 Ω 1 mA
	400 Ω ... 45 kΩ 10 μA
	40 ... 500 kΩ 3 μA
Measuring time	3 seconds refresh rate

1) The accuracy in K defines the deviation between the measured value and the reference value. (Only valid for indicating instruments.)

2) In a range of -20 ... +100 mV

Specifications for thermocouples			
Types	Working range "Temperature"		Working range "Voltage"
	[°C]	[°F]	[mV]
B	250 ... 1,820	482 ... 3,308	0.291 ... 13.820
E	-200 ... +1,000	-328 ... +1,832	-8.825 ... +76.373
J	-210 ... +1,200	-346 ... +2,192	-8.095 ... +69.553
K	-200 ... +1,372	-328 ... +2,502	-5.891 ... +54.886
N	-200 ... +1,300	-328 ... +2,372	-3.990 ... +47.513
R	-50 ... +1,768	-58 ... +3,214	-0.226 ... +21.103
S	-50 ... +1,768	-58 ... +3,214	-0.235 ... +18.693
T	-200 ... +400	-328 ... +752	-5.603 ... +20.872

Communication	
Interface	<input type="checkbox"/> Ethernet <input type="checkbox"/> USB

Voltage supply and performance data	
Power Supply	DC 5.9V/3A via Mensor supplied power supply model: Input: FOX30-X: AC 100-120 /200-240 V; 50/60 Hz; 0.6A

Operating conditions	
Place of use	Indoor Not for wet locations
Operating temperature	0...45 °C [32...113 °F] Maximum achievable accuracy within 17 ... 23 °C [63 ... 73 °F]
Storage temperature range	-20 ... +50 °C [-4 ... +122 °F]
Humidity	0 ... 70 % relative humidity (non-condensing)
Altitude	2000 Meters
Overvoltage Category	I
Pollution Degree	Degree 2
Wet Location	Not Applicable
Ingress Protection	IP20

Approvals

Approvals included in the scope of delivery

Logo	Description	Country
CE	EU declaration of conformity	European Union
	EMC directive EN 61326 emission (group 1, class B) and immunity (basic environments)	
	RoHS directive	

Certificates

Certificate	
Calibration	<ul style="list-style-type: none"> ■ Test report for electrical inputs ■ 3.1 calibration certificate per DIN EN 10204 (system calibration) ¹⁾ ■ DKD/DAkkS calibration certificate for electrical inputs ■ DKD/DAkkS calibration certificate (system calibration) ¹⁾
Recommended recalibration interval	1 year (dependent on conditions of use)

1) System calibration means the calibration of a thermometer as a measuring chain with the CTR4000

Approvals and certificates, see website

Dimensions in mm [in]

Front view

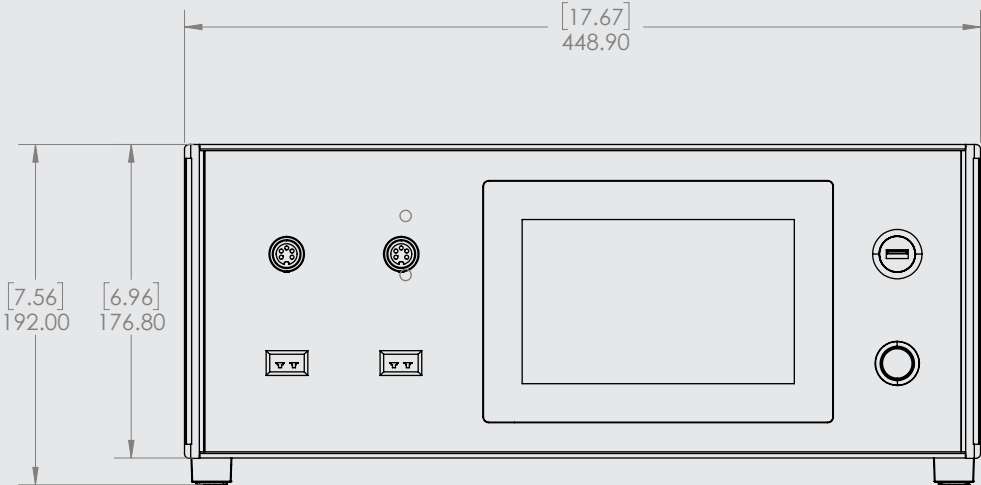

Side view (left)

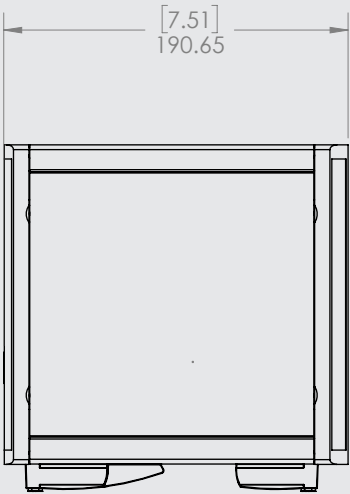

Dimensions in mm [in]

Rear view

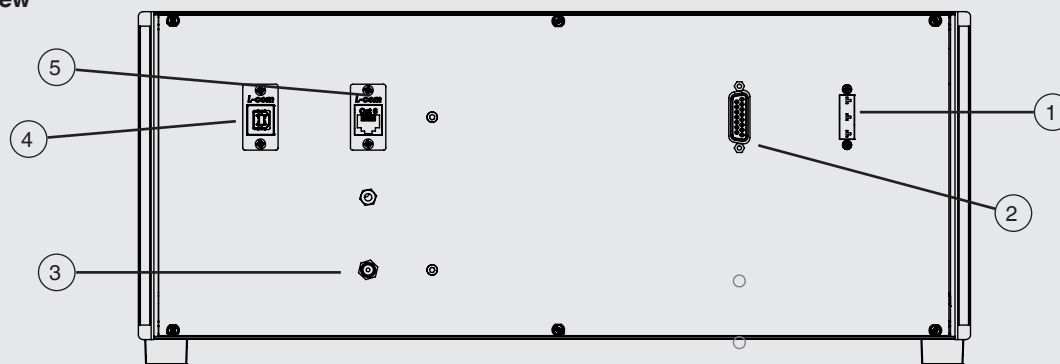

- ① **TC expansion**
Input TC expansion, refer to "Input channel expansion port (CTS expansion, TC expansion)" in product manual.
- ② **CTS Expansion**
Input CTS expansion, refer to "Input channel expansion port (CTS expansion, TC expansion)" in product manual.
- ③ **Power Input**
Connection of the power supply over power supply unit, refer to "Voltage supply" in product manual.
- ④ **USB Device**
USB interface (standard), refer to "USB interface (standard)" in product manual.
- ⑤ **Ethernet**
Ethernet interface (standard), refer to "Ethernet interface" in product manual.

Isometric view

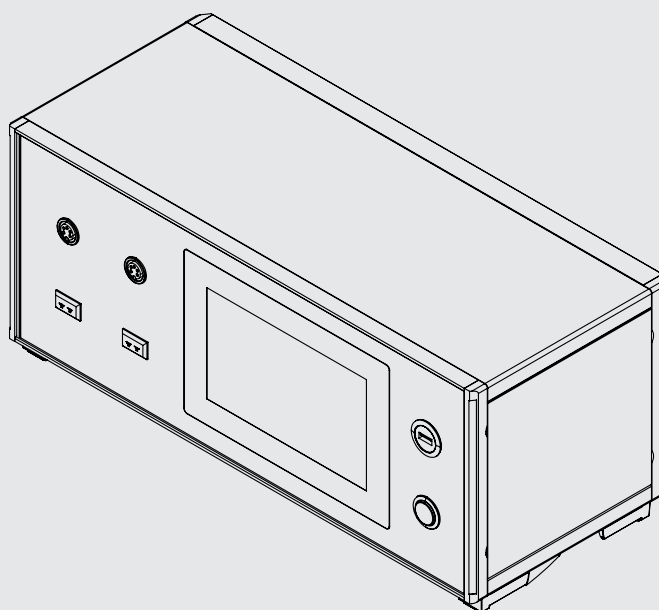

Resistance thermometer connection (5-pin DIN connector) Channel 1 and 2 (PRT1, PRT2)

View towards front panel connector

2-wire PRT connection

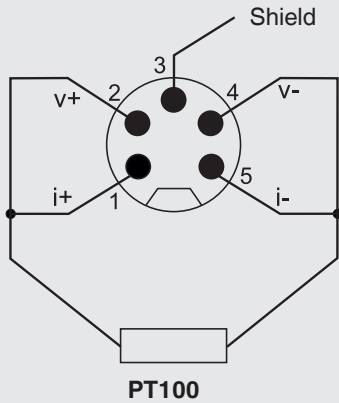

3-wire PRT connection

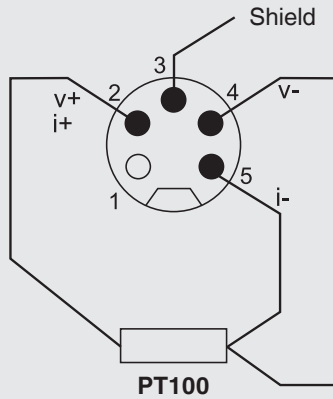

4-wire PRT connection

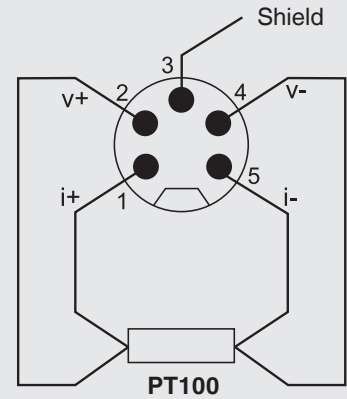

Options

View from top panel

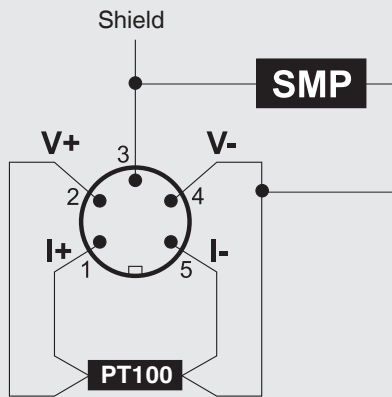

With DIN connector or SMART connector

With ASL's SMART connector on the probes, storing the data is needed only once - in the connector! It can even be used on another instrument without any further action.

The SMART connector saves time and reduces error. If there are existing calibrated or uncalibrated probes, no problem, CTR4000 automatically registers if a probe is SMART or normal.

Thermocouple connection (miniature connector), channel 3 and 4 (TC3, TC4)

Miniature thermocouple plug

Thermocouple connection

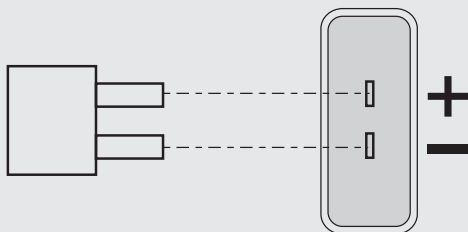

Touchscreen and intuitive user interface

Switching on the instrument, the main screen appears. From here the user can make several settings and can see in this case the measurement in °C of a 4-wire PT25 connected to channel 1.

On the right side the user can select the menus to select inputs or settings.

On the main screen are the function buttons that enable the user to quickly select settings. This is like a shortcut to the menu or an immediate setting.

A click on these guides to a menu which opens on the right side or causes a change on the display.

Standard desktop/main screen

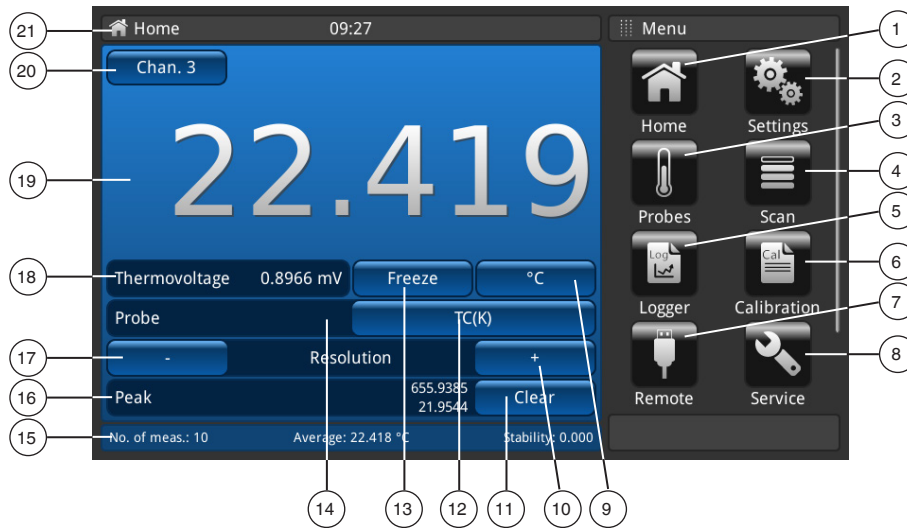

- | | |
|--|--|
| ① Home application | ⑫ Selected probe (standard or custom); shortcut |
| ② General settings | ⑬ Freeze the display; function button |
| ③ Probe settings | ⑭ Root 2 for sensor current PRT; function button |
| ④ Scan settings | ⑮ Current displaying of average, stability and number of measurements |
| ⑤ Logger settings | ⑯ Peak displaying |
| ⑥ Calibration settings | ⑰ Minus decimal place |
| ⑦ Remote settings | ⑱ Measured value in the base unit according to probe, e.g. Ω for Pt100 and mV for TC |
| ⑧ Service settings | ⑲ Current measured value |
| ⑨ Unit; shortcut | ⑳ Selected channel; shortcut |
| ⑩ Plus decimal place | ㉑ Current application name |
| ⑪ Clear the peak values (maximum value, minimum value since starting the instrument) | |

Simple instrument configurations

General instrument settings

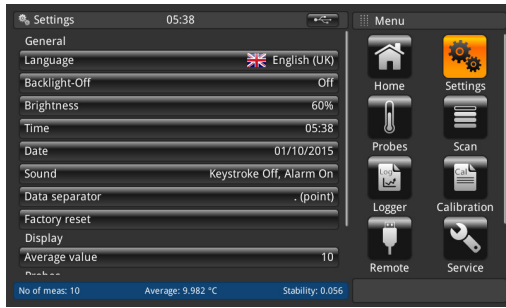

If selecting the menu on the right side, the settings appear on the left side. If, for example, the **[Language]** button is pressed, then all available languages will be displayed on the right hand side and these can easily be selected. In the menu setting all things concerning the instrument can be handled.

Probe settings

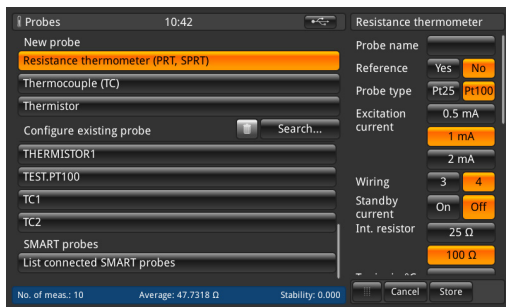

In this menu the probe settings can be selected and the reference thermometers can be stored under a unique name.

Scan settings

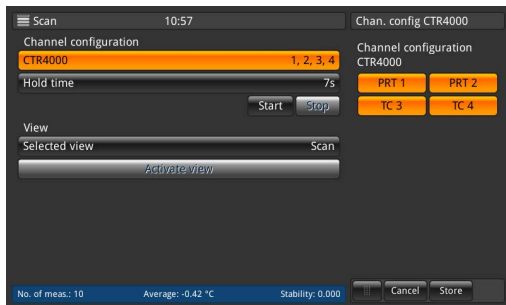

In the scan menu, the user can define a scan by selecting the channels and the hold time. The scan is activated using the start button.

Two views can be selected: Scan and Graph

Due to the wide range of this instrument, no individual instruments are needed which makes the calibration cost-effective. Logger and scan function with a live screen and graph makes calibration life easy.

Scan view

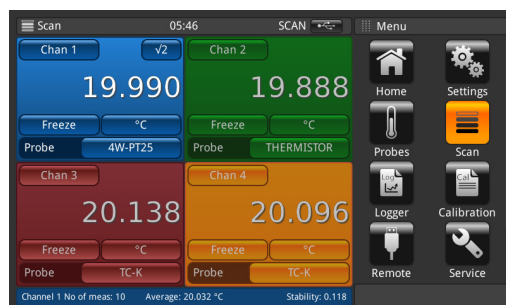

Graphical scan view

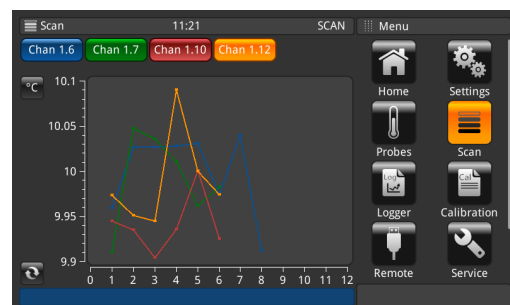

Automated thermometer calibration for model CTR4000 with model CTx9x00

The calibration of temperature probes usually requires considerable effort. This test procedure can be significantly simplified by linking an automated reference thermometer with a temperature source. Such an arrangement allows the creation of individual calibration routines which can be called at any time – calibration just by pushing one button.

The model CTR4000 precision thermometer has four input channels: one for the reference sensor and three for test items.

The stable temperature environment required for the calibration is provided, depending on the test item, in a dry-well calibrator or a micro calibration bath.

One calibration process, two stations – this usually means separate preparation and parameterisation of both instruments. With CTR4000, this preliminary stage can be omitted. The precision thermometer can be linked with a corresponding temperature source from the CTx9x00 series via the respective communication interface using a special feature.

This combination creates a hardware unit for individual and reproducible calibration routines where all measured values of the connected thermometers are recorded and the test temperature is provided automatically. The touchscreen user interface of the calibration instrument makes it easier for the operator to enter information.

Each created routine is saved in the precision thermometer and can be called later on. Since the entire calibration process is automatic, the user only needs to press the Start button. The user does not need to be present until the end of the process which may take several hours in some cases. Nevertheless, the user can monitor the test process on the screen of CTR4000, if required. All calibration phases are logged by a data logger and all data is saved. Subsequently, this information can be downloaded to a USB stick, exported to the XML and CSV format and processed. All calibration routines can be reproduced for subsequent test processes.

Further details

We are expanding our product range of precision thermometers to a versatile thermometer for the industrial market with the model CTR4000 multi-functional precision thermometer. The ability to measure up to 44 resistance thermometers, thermocouples and thermistors simultaneously makes the instrument versatile in application.

The CTR4000 is new in its class. This instrument closes the gap between the hand-held series CTH6x00 which can handle thermocouples and the desktop instrument like model CTR2000 which can only handle resistance thermometers.

It is a precision instrument, designed for use in a laboratory or light industrial environment. The instrument can be extended by using multiplexers to gain additional channels.

The instrument model CTR4000 is compatible with the existing model CTS3000 multiplexer for resistance thermometers and thermocouples. In addition, the user interface is easy to handle like other WIKA calibration technology products.

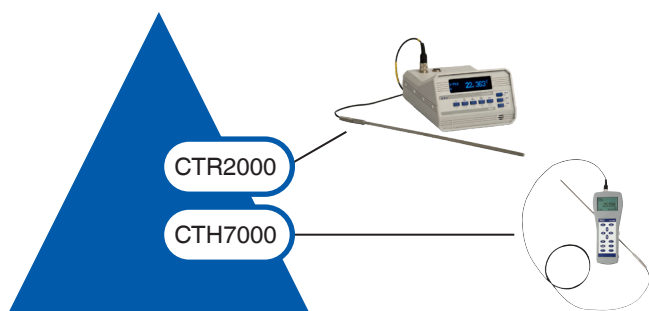

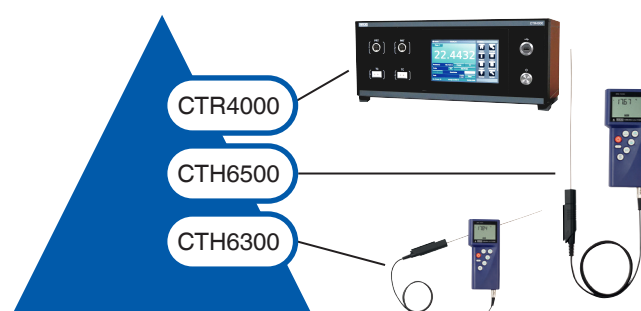

RTD measurement



TC and PRT measurements

Accessories and spare parts

Description	Order code
 Case Transport case, robust	CTX-A-A1 -T1-
 Multiplexer model CTS3000 10-channel multiplexer as desktop case For resistance thermometers and thermocouples (maximum of 4 multiplexers per CTR4000)	-CD-
 Multiplexer model CTS3000 10-channel multiplexer with built-in case for 19" rack For resistance thermometers and thermocouples (maximum of 4 multiplexers per CTR4000)	-CR-
 Adapter To connect a thermometer with bare cable ends	-AD-
 Adapter cable CTS3000 5 x 4 mm banana plug to 5-pin DIN socket	A3
 Adapter cable CTR4000 5 x 4 mm banana socket to 5-pin DIN connector	AE
 15-pin interface cable For resistance thermometers Length: 0.75 m [2.5 ft]	I5
 TC interface cable For thermocouples Length: 0.75 m [2.5 ft]	I6
Ordering information for your enquiry:	
1. Order code: CTX-A-A1 2. Option:	↓ []

Description	Order code
 Temperature probe model CTP5000 Immersion probe	CTP5000
 Reference Thermometer model CTP6000 high-accuracy temperature measurement	CTP6000

Accessories and spare parts

Description	Order code
 <p>Thermocouple model CTP9000 Immersion probe type S With or without cold junction</p>	CTP9000

Scope of delivery

- Model CTR4000 multi-functional precision thermometer incl. AC adapter
- Test report for electrical inputs
- Calibration certificate (system calibration only if ordered together with a probe)
- Operating instructions

1) System calibration means the calibration of a thermometer as a measuring chain with the CTR4000

Ordering information

CTR4000 / Interface / Number of multiplexers / Number of resistance thermometers / Number of thermocouples CTP9000 / Calibration / Transport case / Further approvals / Additional ordering information

tempcontrol

+31 15 251 18 31
info@tempcontrol.nl
tempcontrol.nl

© 04/2025 WIKA Alexander Wiegand SE & Co. KG, all rights reserved.
The specifications given in this document represent the state of engineering at the time of publishing.
We reserve the right to make modifications to the specifications and materials.
In case of a different interpretation of the translated and the English data sheet, the English wording shall prevail.